

Unit in mm

High Power Switching Applications

Motor Control Applications

- Integrates Inverter, Converter and Brake Power Circuits in One Package.
- Output (Inverter Stage)
 - : 3ø20A/600V High Speed Type IGBT
 - $V_{CE(sat)} = 4.00V$ (Max.)
 - $t_f = 0.30\mu s$ (Max.)
 - $t_{rr} = 0.15\mu s$ (Max.)
- Input (Converter Stage)
 - : 1ø30A/800V Silicon Rectifier
 - $V_F = 1.20V$ (Max.)
- Brake Stage
 - : 15A/600V IGBT & 15A/600V FRD
- The Electrodes are Isolated from Case.

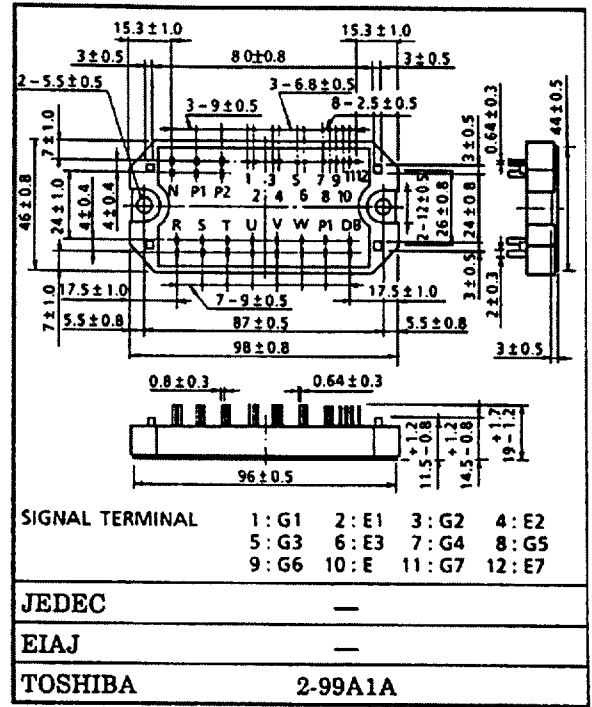

Weight : 175g

Equivalent Circuit

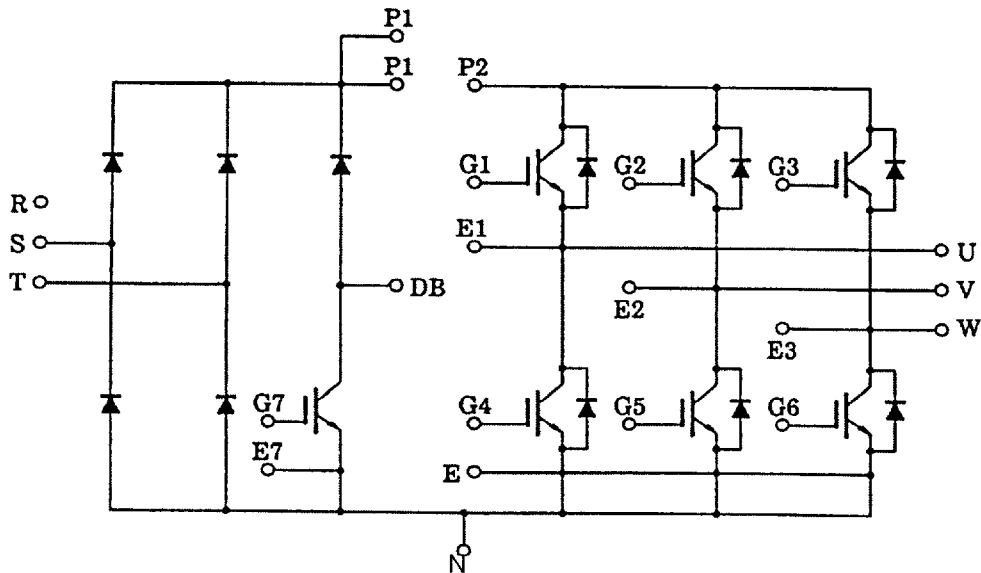

The information contained here is subject to change without notice. The information contained herein is presented only as guide for the applications of our products. No responsibility is assumed by TOSHIBA for any infringements of patents or other rights of the third parties which may result from its use. No license is granted by implication or otherwise under any patent or patent rights of TOSHIBA or others. These TOSHIBA products are intended for usage in general electronic equipments (office equipment, communication equipment, measuring equipment, domestic electrification, etc.) Please make sure that you consult with us before you use these TOSHIBA products in equipments which require high quality and/or reliability, and in equipments which could have major impact to the welfare of human life (atomic energy control, spaceship, traffic signal, combustion control, all types of safety devices, etc.). TOSHIBA cannot accept liability to any damage which may occur in case these TOSHIBA products were used in the mentioned equipments without prior consultation with TOSHIBA.

MIG20J951H
Maximum Ratings (Ta = 25°C)

STAGE		CHARACTERISTIC		SYMBOL	RATINGS	UNIT		
Inverter		Collector-Emitter Voltage		V_{CES}	600	V		
		Gate-Emitter Voltage		V_{GES}	±20	V		
		Collector Current		DC	I_C	20	A	
				1ms	I_{CP}	40		
		Forward Current		DC	I_F	20	A	
1ms	I_{FM}			40				
		Collector Power Dissipation (Tc = 25°C)		P_C	80	W		
Converter		Repetitive Peak Reverse Voltage		V_{RRM}	800	V		
		Average Output Rectified Current		I_O	30	A		
		Peak One Cycle Surge Forward Current (50Hz, Non-Repetitive)		I_{FSM}	400	A		
Brake		Collector-Emitter Voltage		V_{CES}	600	V		
				Gate-Emitter Voltage		V_{GES}	±20	V
		Collector Current				DC	I_C	15
				1ms	I_{CP}	30		
				Collector Power Dissipation (Tc = 25°C)		P_C	65	W
		FRD		Repetitive Peak Reverse Voltage		V_{RRM}	600	V
				Forward Current		DC	I_F	15
1ms	I_{FM}					30		
Module		Junction Temperature		T_j	150	°C		
		Storage Temperature Range		T_{stg}	-40 ~ 125	°C		
		Isolation Voltage		V_{isol}	2500 (AC 1 minute)	V		
		Screw Torque		—	3	N•m		

Electrical Characteristics (Ta = 25°C)

a. Inverter Stage

CHARACTERISTIC		SYMBOL	TEST CONDITION	MIN.	TYP.	MX.	UNIT
Gate Leakage Current		I_{GES}	$V_{GE} = \pm 20V, V_{CE} = 0$	–	–	± 20	μA
Collector Cut-off Current		I_{CES}	$V_{CE} = 600V, V_{GE} = 0$	–	–	1.0	mA
Gate-Emitter Cut-off Voltage		$V_{GE (off)}$	$V_{CE} = 5V, I_C = 20mA$	3.0	–	6.0	V
Collector-Emitter Saturation Voltage		$V_{CE (sat)}$	$I_C = 20A, V_{GE} = 15V$	–	3.0	4.0	V
Input Capacitance		C_{ies}	$V_{CE} = 10V, V_{GE} = 0$ $f = 1MHz$	–	1300	–	pF
Switching Time	Turn-on Delay Time	$t_{d(on)}$	Inductive Load $V_{CC} = 300V$ $I_C = 20A$ $V_{GE} = \pm 15V$ $R_G = 120\Omega$ (Note 1)	–	0.08	0.16	μs
	Rise Time	t_r		–	0.12	0.24	
	Turn-on Time	t_{on}		–	0.40	0.80	
	Turn-off Delay Time	$t_{d(off)}$		–	0.30	0.60	
	Fall Time	t_f		–	0.15	0.30	
	Turn-off Time	t_{off}		–	0.60	1.00	
Forward Voltage		V_F	$I_F = 20A, V_{GE} = 0$	–	1.7	2.5	V
Reverse Recovery Time		t_{rr}	$I_F = 20A, V_{GE} = -10V$ $di/dt = 50A/\mu s$	–	0.08	0.15	μs
Thermal Resistance		$R_{th(j-c)}$	Transistor	–	–	1.56	$^{\circ}C/W$
			Diode	–	–	2.80	

b. Converter Stage

CHARACTERISTIC	SYMBOL	TEST CONDITION	MIN.	TYP.	MX.	UNIT
Repetitive Peak Reverse Current	I_{RRM}	$V_{RRM} = 800V$	–	–	50	μA
Peak Forward Voltage	V_{FM}	$I_{FM} = 30A$	–	1.05	1.20	V
Peak One Cycle Surge Forward Current	I_{FSM}	50Hz Sine-half-wave	400	–	–	A
Thermal Resistance	$R_{th(j-c)}$	–	–	–	1.56	$^{\circ}C/W$

MIG20J951H

c. Brake Stage

CHARACTERISTIC		SYMBOL	TEST CONDITION	MIN.	TYP.	MX.	UNIT
Gate Leakage Current		I_{GES}	$V_{GE} = \pm 20V, V_{CE} = 0$	-	-	± 20	μA
Collector Cut-off Current		I_{CES}	$V_{CE} = 600V, V_{GE} = 0$	-	-	1.0	mA
Repetitive Peak Reverse Current		I_{RRM}	$V_{RRM} = 600V$	-	-	1.0	mA
Gate-Emitter Cut-off Voltage		$V_{GE(off)}$	$V_{CE} = 5V, I_C = 15mA$	3.0	-	6.0	V
Collector-Emitter Saturation Voltage		$V_{CE(sat)}$	$I_C = 15A, V_{GE} = 15V$	-	3.0	4.0	V
Input Capacitance		C_{ies}	$V_{CE} = 10V, V_{GE} = 0$ $f = 1MHz$	-	1000	-	pF
Switching Time	Turn-on Delay Time	$t_{d(on)}$	Inductive Load $V_{CC} = 300V$ $I_C = 15A$ $V_{GE} = \pm 15V$ $R_G = 150\Omega$ (Note 1)	-	0.08	0.16	μs
	Rise Time	t_r		-	0.12	0.24	
	Turn-on Time	t_{on}		-	0.40	0.80	
	Turn-off Delay Time	$t_{d(off)}$		-	0.30	0.60	
	Fall Time	t_f		-	0.30	0.55	
	Turn-off Time	t_{off}		-	0.65	1.00	
Forward Voltage		V_F	$I_F = 15A, V_{GE} = 0$	-	1.7	2.5	V
Thermal Resistance		$R_{th(j-c)}$	Transistor	-	-	1.92	$^{\circ}C/W$
			Diode	-	-	2.80	

Note. 1 Switching Time Test Circuit & Timing Chart

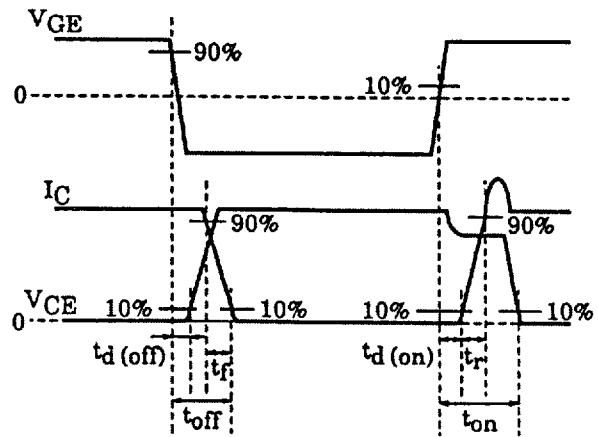
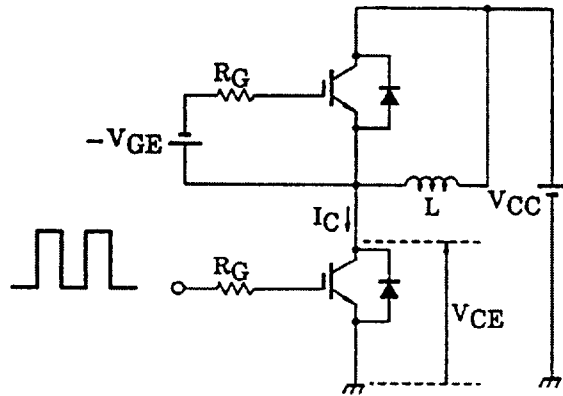

a. Inverter Stage

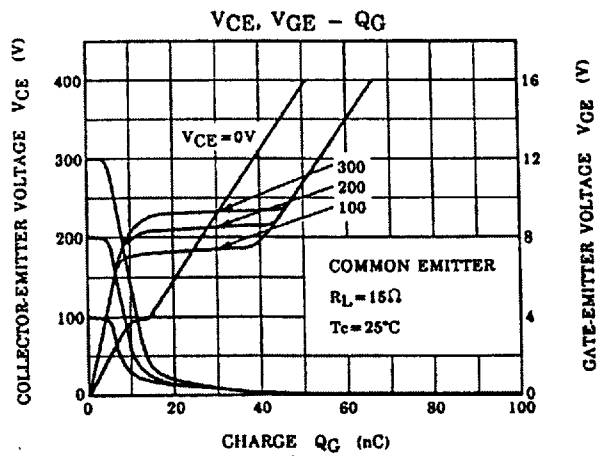
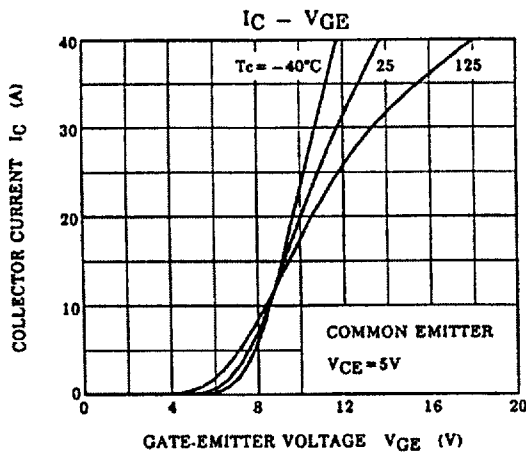
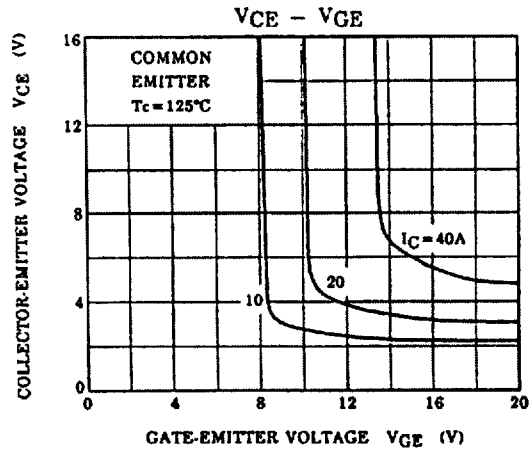
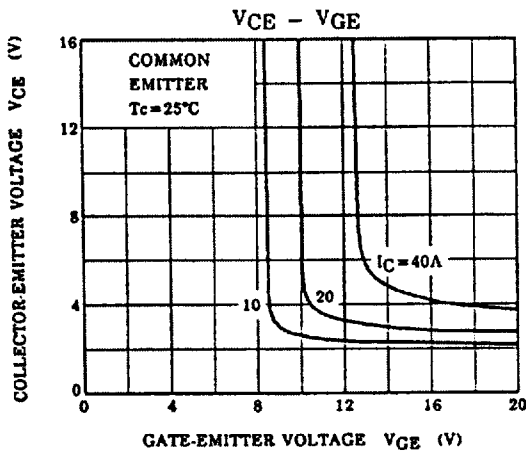
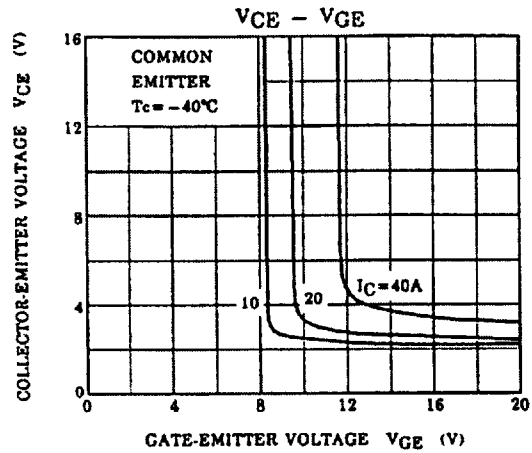
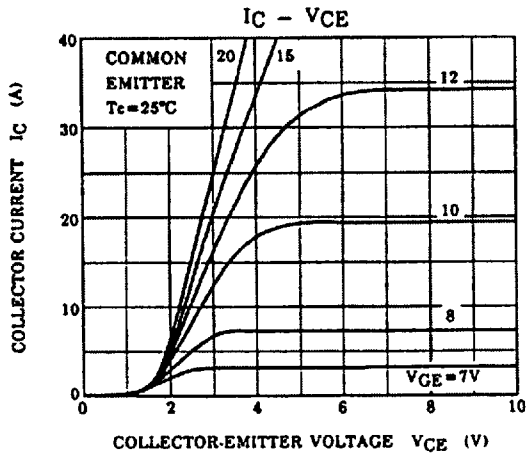

a. Inverter Stage

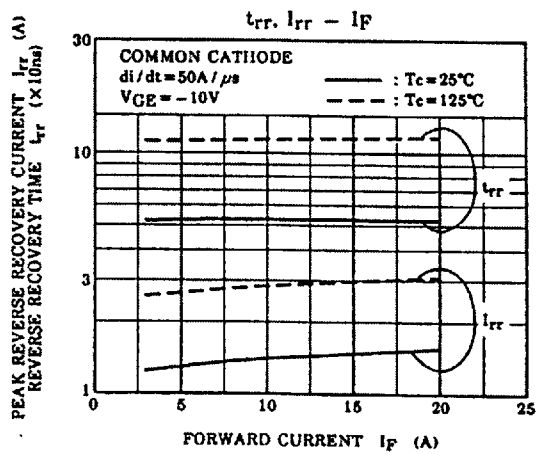
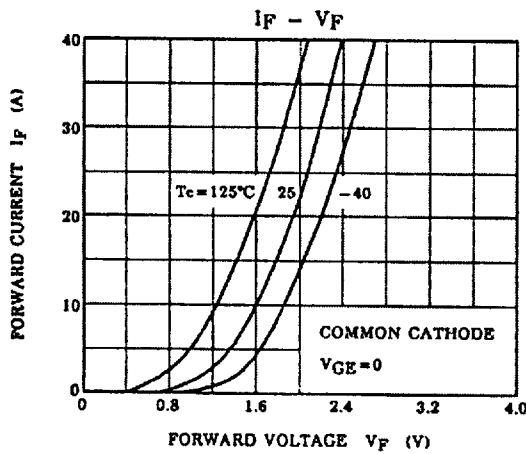
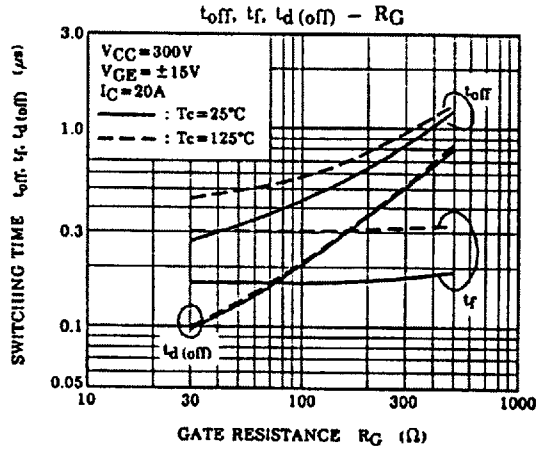
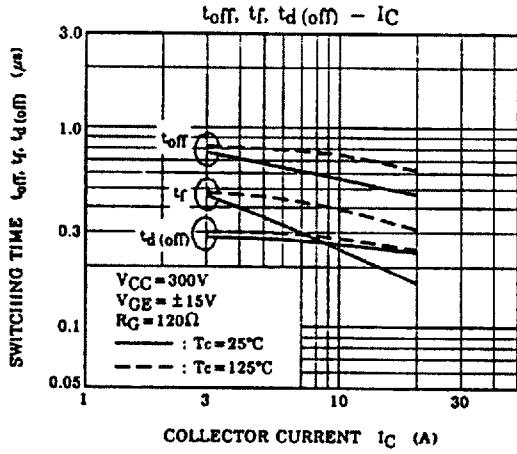
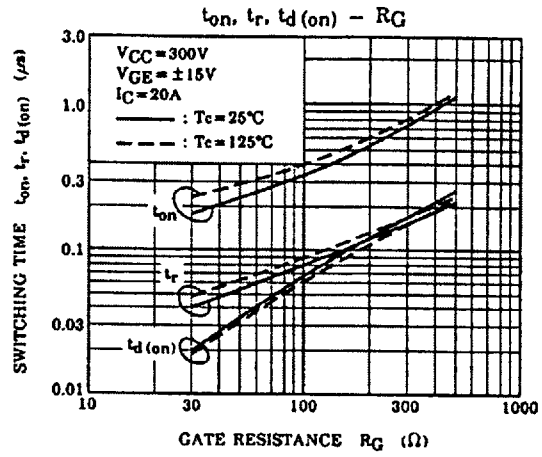
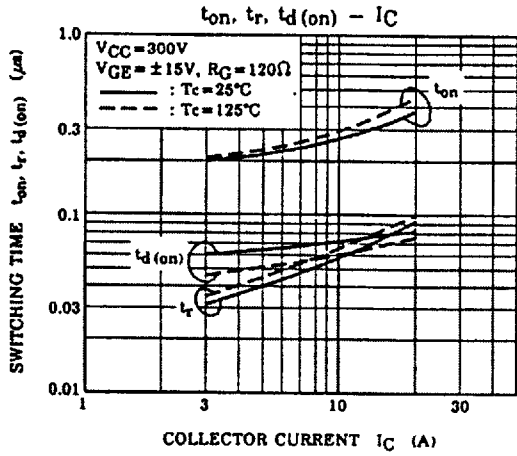

a. Inverter Stage

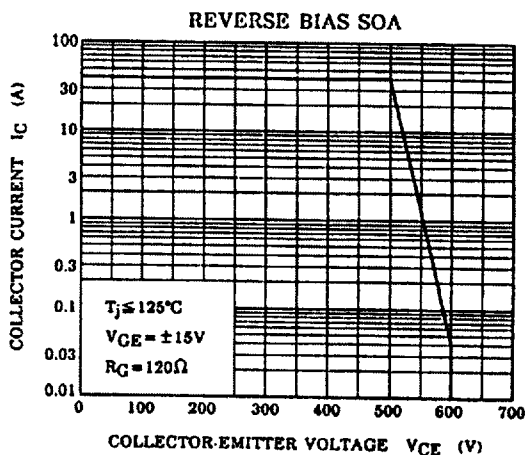
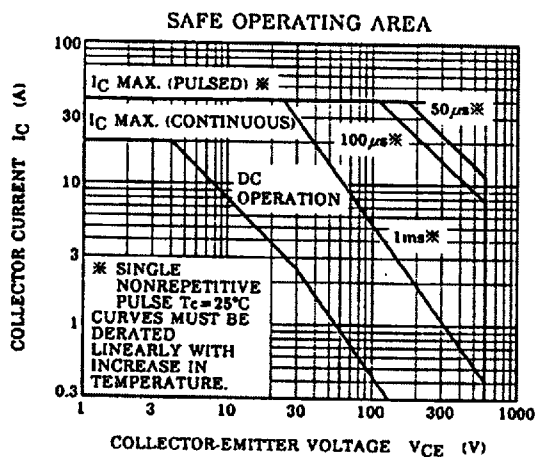
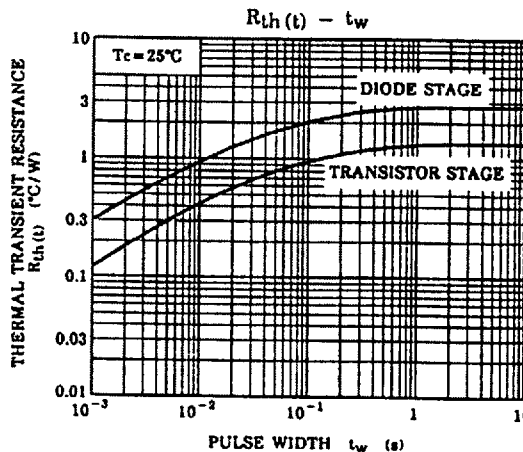
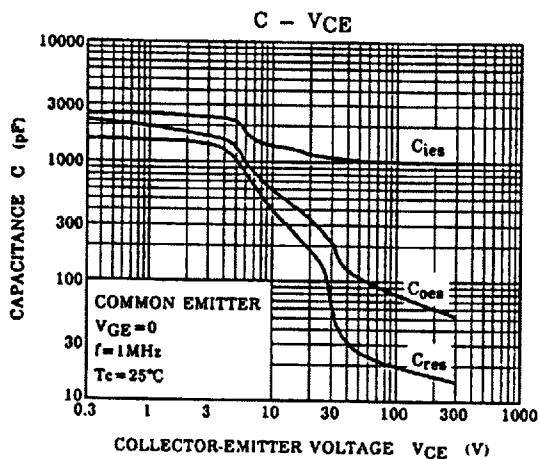

MIG20J951H

b. Converter Stage

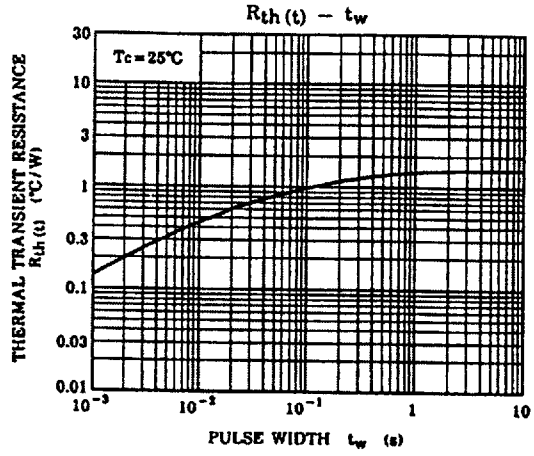
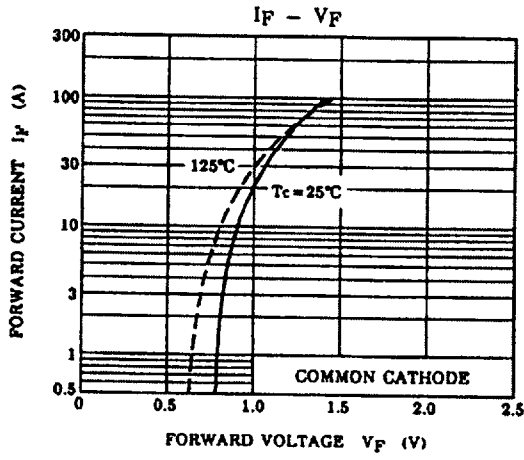

c. Brake Stage

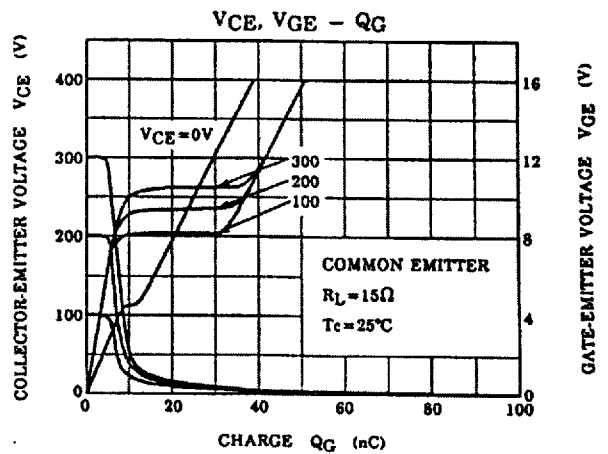
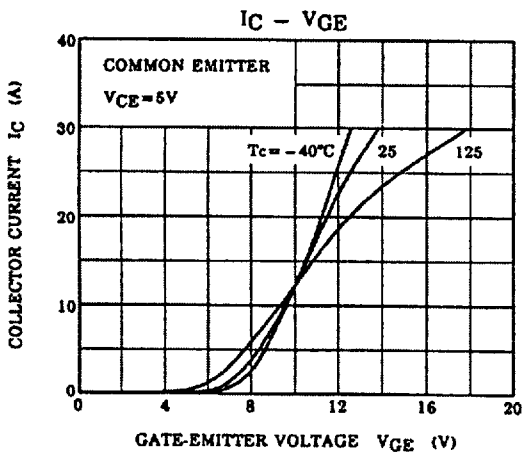
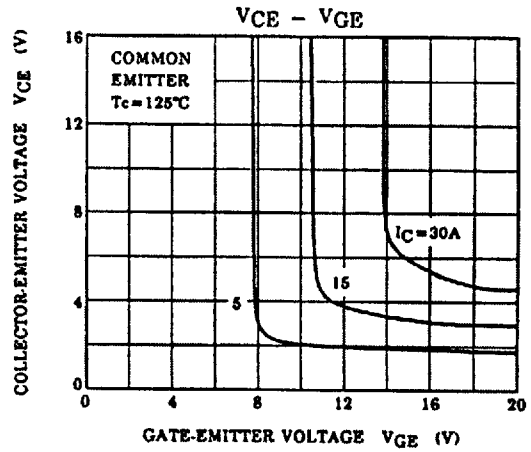
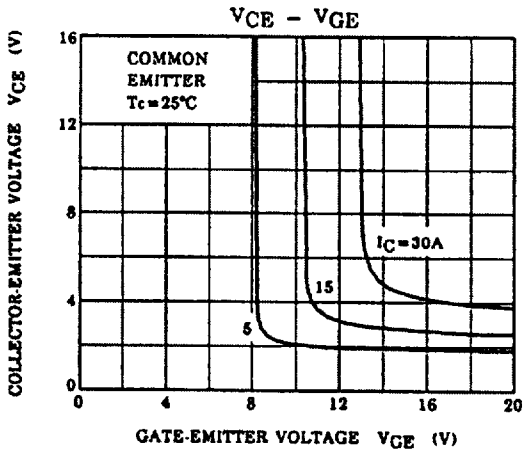
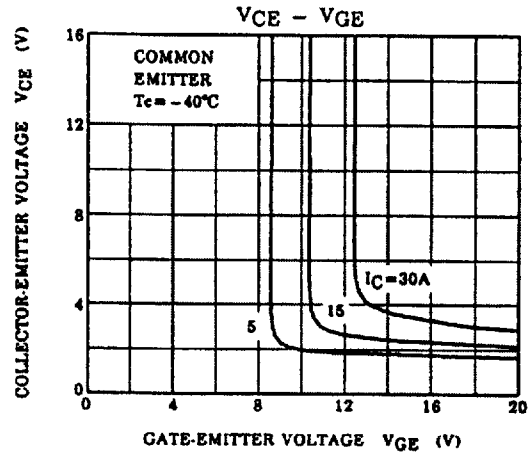
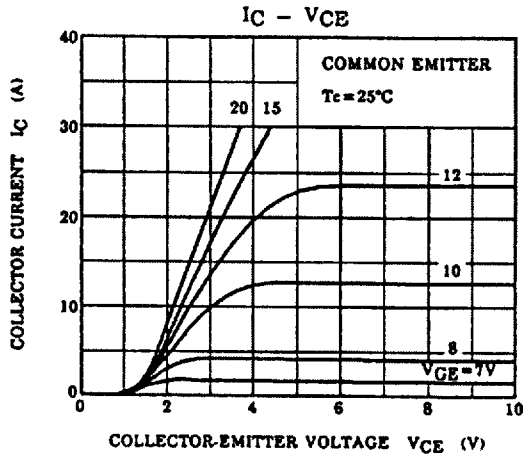

MIG20J951H

c. Brake Stage

(MIG20J951H)

c. Brake Stage

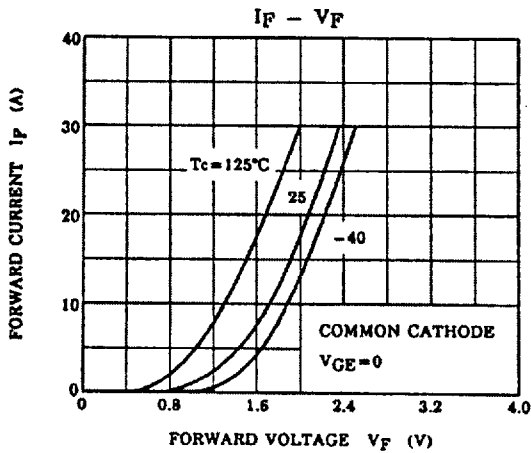
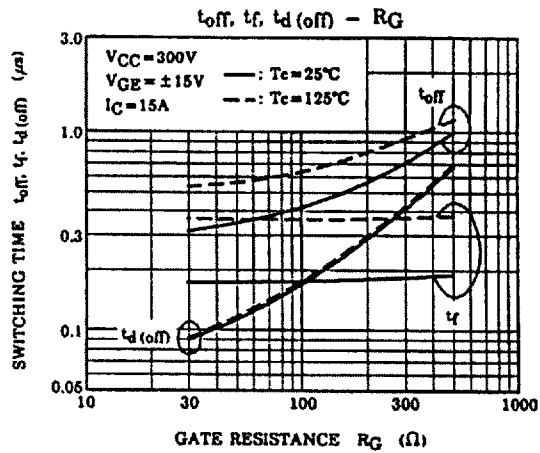
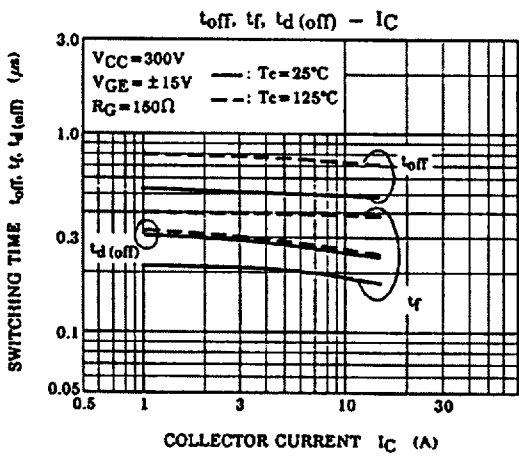
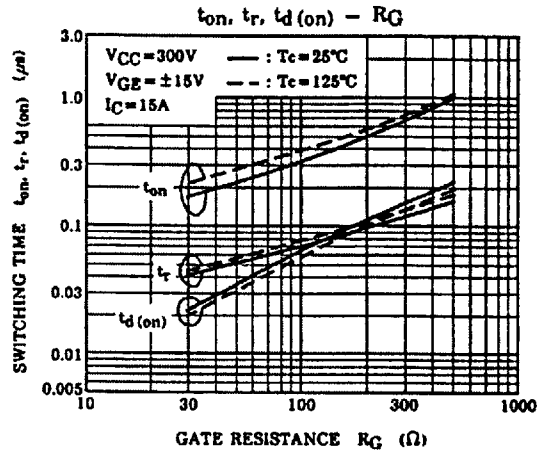
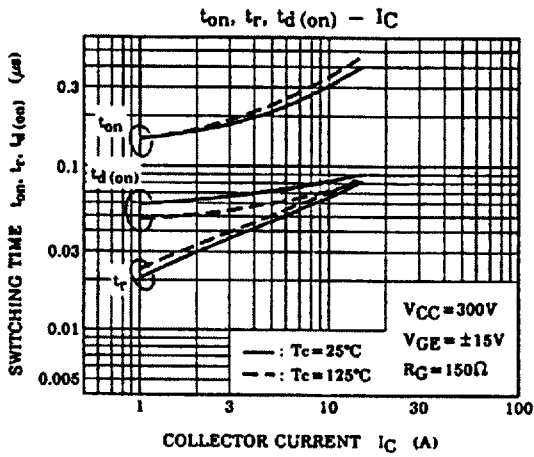

c. Brake Stage

